

MC74LVX50

Hex Buffer

The MC74LVX50 is an advanced high speed CMOS buffer fabricated with silicon gate CMOS technology.

The internal circuit is composed of three stages, including a buffered output which provides high noise immunity and stable output. The inputs tolerate voltages up to 7.0 V, allowing the interface of 5.0 V systems to 3.0 V systems.

Features

- High Speed: $t_{PD} = 4.1 \text{ ns (Typ)}$ at $V_{CC} = 3.3 \text{ V}$
- Low Power Dissipation: $I_{CC} = 2 \mu\text{A (Max)}$ at $T_A = 25^\circ\text{C}$
- High Noise Immunity: $V_{NIH} = V_{NIL} = 28\% V_{CC}$
- Power Down Protection Provided on Inputs
- Balanced Propagation Delays
- Designed for 2.0 V to 3.6 V Operating Range
- Low Noise: $V_{OLP} = 0.5 \text{ V (Max)}$
- Pb-Free Packages are Available*



ON Semiconductor®

<http://onsemi.com>

MARKING DIAGRAMS

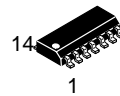

SOIC-14
D SUFFIX
CASE 751A

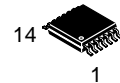
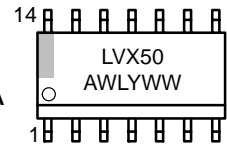

TSSOP-14
DT SUFFIX
CASE 948G

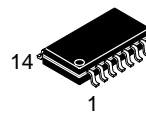
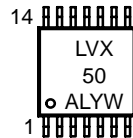

SOEIAJ-14
M SUFFIX
CASE 965

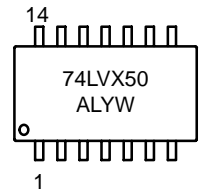

A = Assembly Location
WL or L = Wafer Lot
Y = Year
WW or W = Work Week

ORDERING INFORMATION

See detailed ordering and shipping information in the package dimensions section on page 2 of this data sheet.

*For additional information on our Pb-Free strategy and soldering details, please download the ON Semiconductor Soldering and Mounting Techniques Reference Manual, SOLDERRM/D.

MC74LVX50

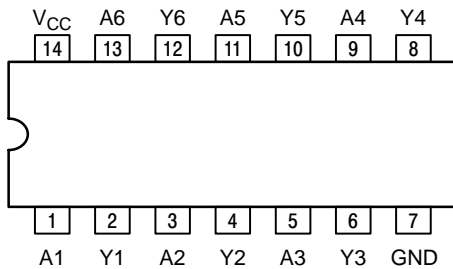
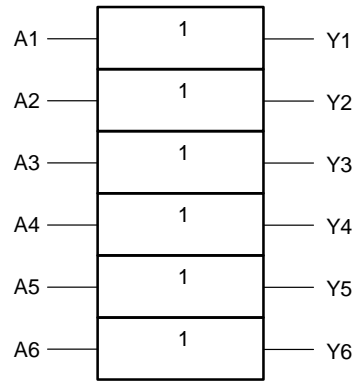
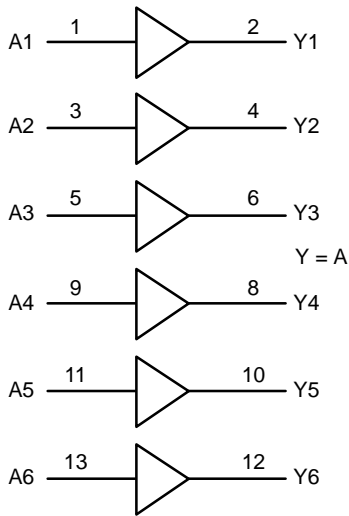

FUNCTION TABLE

A Input	Y Output
L	L
H	H

ORDERING INFORMATION

Device	Package	Shipping†
MC74LVX50D	SOIC-14	55 Units / Rail
MC74LVX50DG	SOIC-14 (Pb-Free)	55 Units / Rail
MC74LVX50DR2	SOIC-14	2500 Tape & Reel
MC74LVX50DR2G	SOIC-14 (Pb-Free)	2500 Tape & Reel
MC74LVX50DT	TSSOP-14*	96 Units / Rail
MC74LVX50DTR2	TSSOP-14*	2500 Tape & Reel
MC74LVX50M	SOEIAJ-14	50 Units / Rail
MC74LVX50MG	SOEIAJ-14 (Pb-Free)	50 Units / Rail
MC74LVX50MEL	SOEIAJ-14	2000 Tape & Reel
MC74LVX50MELG	SOEIAJ-14 (Pb-Free)	2000 Tape & Reel

†For information on tape and reel specifications, including part orientation and tape sizes, please refer to our Tape and Reel Packaging Specifications Brochure, BRD8011/D.

*This package is inherently Pb-Free.

MC74LVX50

MAXIMUM RATINGS

Symbol	Parameter	Value	Unit
V _{CC}	DC Supply Voltage	-0.5 to +7.0	V
V _{IN}	DC Input Voltage	-0.5 to +7.0	V
V _{OUT}	DC Output Voltage	-0.5 to V _{CC} + 0.5	V
I _{IK}	DC Input Diode Current V _I < GND	-20	mA
I _{OK}	DC Output Diode Current V _O < GND	±20	mA
I _{OUT}	DC Output Sink Current	±25	mA
I _{CC}	DC Supply Current per Supply Pin	±50	mA
T _{STG}	Storage Temperature Range	-65 to +150	°C
T _L	Lead Temperature, 1 mm from Case for 10 Seconds	260	°C
T _J	Junction Temperature under Bias	+150	°C
θ _{JA}	Thermal Resistance (Note 1) SOIC TSSOP	125 170	°C/W
MSL	Moisture Sensitivity	Level 1	
F _R	Flammability Rating Oxygen Index: 30% – 35%	UL 94-V0 @ 0.125 in	
V _{ESD}	ESD Withstand Voltage Human Body Model (Note 2) Machine Model (Note 3) Charged Device Model (Note 4)	> 2000 > 200 2000	V
I _{Latchup}	Latchup Performance Above V _{CC} and Below GND at 85°C (Note 5)	±300	mA

Maximum ratings are those values beyond which device damage can occur. Maximum ratings applied to the device are individual stress limit values (not normal operating conditions) and are not valid simultaneously. If these limits are exceeded, device functional operation is not implied, damage may occur and reliability may be affected.

1. Measured with minimum pad spacing on an FR4 board, using 10 mm-by-1 inch, 2-ounce copper trace with no air flow.
2. Tested to EIA/JESD22-A114-A.
3. Tested to EIA/JESD22-A115-A.
4. Tested to JESD22-C101-A.
5. Tested to EIA/JESD78.

RECOMMENDED OPERATING CONDITIONS

Symbol	Parameter	Min	Max	Unit
V _{CC}	Supply Voltage	2.0	3.6	V
V _I	Input Voltage (Note 6)	0	5.5	V
V _O	Output Voltage (HIGH or LOW State)	0	V _{CC}	V
T _A	Operating Free-Air Temperature	-40	+85	°C
Δt/ΔV	Input Transition Rise or Fall Rate V _{CC} = 3.0 V ± 0.3 V	0	100	ns/V

6. Unused inputs may not be left open. All inputs must be tied to a high- or low-logic input voltage level.

NOTE: The θ_{JA} of the package is equal to 1/Derating. Higher junction temperatures may affect the expected lifetime of the device per the table and figure below.

MC74LVX50

DC ELECTRICAL CHARACTERISTICS

Symbol	Parameter	Test Conditions	V _{CC} (V)	T _A = 25°C			T _A ≤ 85°C		Unit
				Min	Typ	Max	Min	Max	
V _{IH}	High-Level Input Voltage		2.0 3.0 3.6	1.5 2.0 2.4			1.5 2.0 2.4		V
V _{IL}	Low-Level Input Voltage		2.0 3.0 3.6			0.5 0.8 0.8		0.5 0.8 0.8	V
V _{OH}	High-Level Output Voltage (V _{IN} = V _{IH} or V _{IL})	I _{OH} = -50 μA I _{OH} = -50 μA I _{OH} = -4 mA	2.0 3.0 3.0	1.9 2.9 2.58	2.0 3.0		1.9 2.9 2.48		V
V _{OL}	Low-Level Output Voltage (V _{IN} = V _{IH} or V _{IL})	I _{OL} = 50 μA I _{OL} = 50 μA I _{OL} = 4 mA	2.0 3.0 3.0		0.0 0.0	0.1 0.1 0.36		0.1 0.1 0.44	V
I _{IN}	Input Leakage Current	V _{IN} = 5.5 V or GND	0 to 3.6			±0.1		±1.0	μA
I _{CC}	Quiescent Supply Current	V _{IN} = V _{CC} or GND	3.6			2.0		20.0	μA

AC ELECTRICAL CHARACTERISTICS Input t_r = t_f = 3.0 ns

Symbol	Parameter	Test Conditions	T _A = 25°C			T _A ≤ 85°C		Unit
			Min	Typ	Max	Min	Max	
t _{PLH} , t _{PHL}	Propagation Delay, Input A to Y	V _{CC} = 2.7 V C _L = 15 pF C _L = 50 pF		5.4 7.9	10.1 13.6	1.0 1.0	12.5 16.0	ns
		V _{CC} = 3.3 V ± 0.3 V C _L = 15 pF C _L = 50 pF		4.1 6.6	6.2 9.7	1.0 1.0	7.5 11.5	
t _{OSSL} , t _{OSLH}	Output-to-Output Skew (Note 7)	V _{CC} = 2.7 V C _L = 50 pF			1.5		1.5	ns
		V _{CC} = 3.3 V ± 0.3V C _L = 50 pF			1.5		1.5	
C _{IN}	Input Capacitance			4	10		10	pF
C _{PD}	Power Dissipation Capacitance (Note 8)		Typical @ 25°C, V _{CC} = 3.3 V					
			15					pF

7. Skew is defined as the absolute value of the difference between the actual propagation delay for any two separate outputs of the same device. The specification applies to any outputs switching in the same direction, either HIGH-to-LOW (t_{OSSL}) or LOW-to-HIGH (t_{OSLH}); parameter guaranteed by design.
8. C_{PD} is defined as the value of the internal equivalent capacitance which is calculated from the operating current consumption without load. Average operating current can be obtained by the equation: I_{CC(OPR)} = C_{PD} • V_{CC} • f_{in} + I_{CC}. C_{PD} is used to determine the no-load dynamic power consumption; P_D = C_{PD} • V_{CC}² • f_{in} + I_{CC} • V_{CC}.

NOISE CHARACTERISTICS Input t_r = t_f = 3.0ns, C_L = 50pF, V_{CC} = 3.3 V

Symbol	Characteristic	T _A = 25°C		Unit
		Typ	Max	
V _{OLP}	Quiet Output Maximum Dynamic V _{OL}	0.3	0.5	V
V _{OLV}	Quiet Output Minimum Dynamic V _{OL}	-0.3	-0.5	V
V _{IHD}	Minimum High Level Dynamic Input Voltage		2.0	V
V _{ILD}	Maximum Low Level Dynamic Input Voltage		0.8	V

MC74LVX50

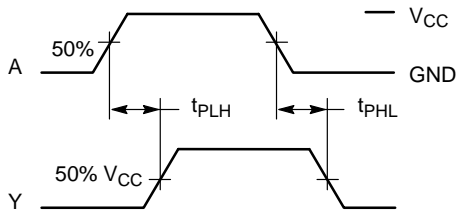
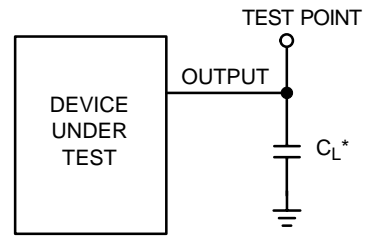

Figure 3. Switching Waveforms



*Includes all probe and jig capacitance

Figure 4. Test Circuit

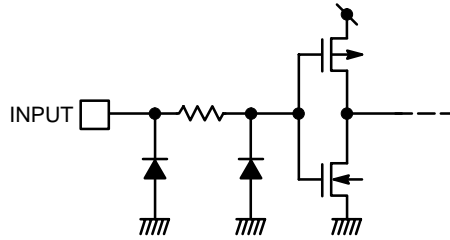

Figure 5. Input Equivalent Circuit

EMBOSED CARRIER DIMENSIONS (See Notes 9 and 10)

Tape Size	B ₁ Max	D	D ₁	E	F	K	P	P ₀	P ₂	R	T	W
8 mm	4.35 mm (0.179")	1.5 mm + 0.1 -0.0 (0.059")	1.0 mm Min (0.179")	1.75 mm ±0.1 (0.069 ±0.004")	3.5 mm ±0.5 (1.38 ±0.002")	2.4 mm Max (0.094")	4.0 mm ±0.10 (0.157 ±0.004")	4.0 mm ±0.1 (0.157 ±0.004")	2.0 mm ±0.1 (0.079 ±0.004")	25 mm (0.98")	0.6 mm (0.024)	8.3 mm (0.327)
12 mm	8.2 mm (0.323")	+0.004 -0.0)	1.5 mm Min (0.060)		5.5 mm ±0.5 (0.217 ±0.002")	6.4 mm Max (0.252")	4.0 mm ±0.10 (0.157 ±0.004") 8.0 mm ±0.10 (0.315 ±0.004")			30 mm (1.18")		12.0 mm ±0.3 (0.470 ±0.012")
16 mm	12.1 mm (0.476")				7.5 mm ±0.10 (0.295 ±0.004")	7.9 mm Max (0.311")	4.0 mm ±0.10 (0.157 ±0.004") 8.0 mm ±0.10 (0.315 ±0.004") 12.0 mm ±0.10 (0.472 ±0.004")					16.3 mm (0.642)
24 mm	20.1 mm (0.791")				11.5 mm ±0.10 (0.453 ±0.004")	11.9 mm Max (0.468")	16.0 mm ±0.10 (0.63 ±0.004")					24.3 mm (0.957)

9. Metric Dimensions Govern—English are in parentheses for reference only.

10. A₀, B₀, and K₀ are determined by component size. The clearance between the components and the cavity must be within 0.05 mm min to 0.50 mm max. The component cannot rotate more than 10° within the determined cavity

MC74LVX50

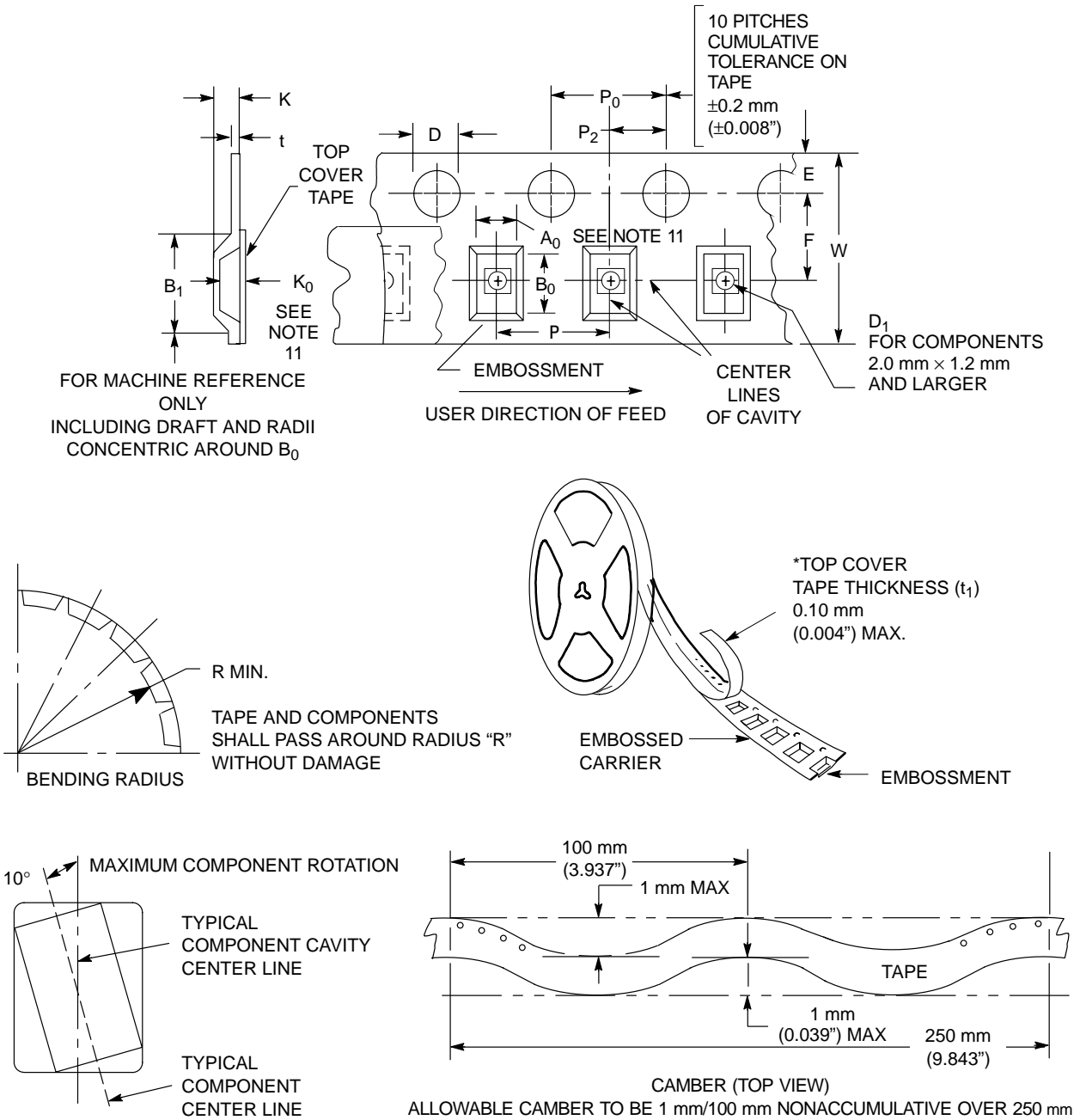

11. A_0 , B_0 , and K_0 are determined by component size. The clearance between the components and the cavity must be within 0.05 mm min to 0.50 mm max. The component cannot rotate more than 10° within the determined cavity

Figure 6. Carrier Tape Specifications

MC74LVX50

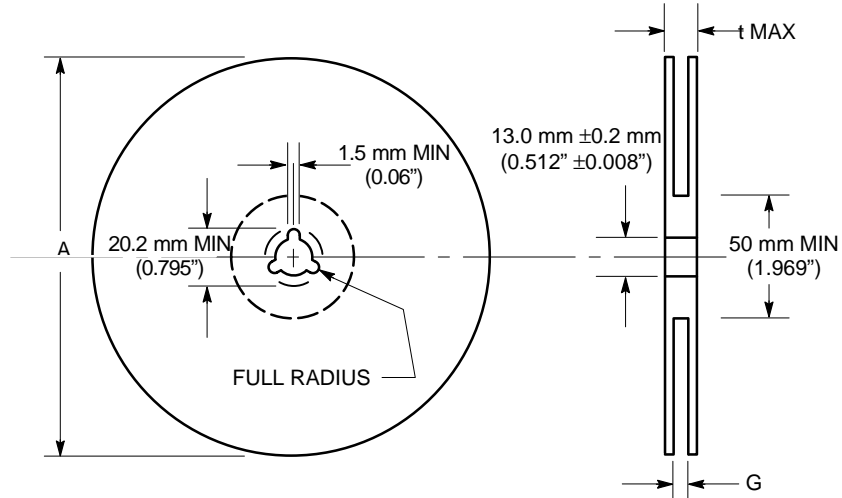

Figure 7. Reel Dimensions

REEL DIMENSIONS

Tape Size	T&R Suffix	A Max	G	t Max
8 mm	T1, T2	178 mm (7")	8.4 mm, +1.5 mm, -0.0 (0.33" + 0.059", -0.00)	14.4 mm (0.56")
8 mm	T3, T4	330 mm (13")	8.4 mm, +1.5 mm, -0.0 (0.33" + 0.059", -0.00)	14.4 mm (0.56")
12 mm	R2	330 mm (13")	12.4 mm, +2.0 mm, -0.0 (0.49" + 0.079", -0.00)	18.4 mm (0.72")
16 mm	R2	360 mm (14.173")	16.4 mm, +2.0 mm, -0.0 (0.646" + 0.078", -0.00)	22.4 mm (0.882")
24 mm	R2	360 mm (14.173")	24.4 mm, +2.0 mm, -0.0 (0.961" + 0.078", -0.00)	30.4 mm (1.197")

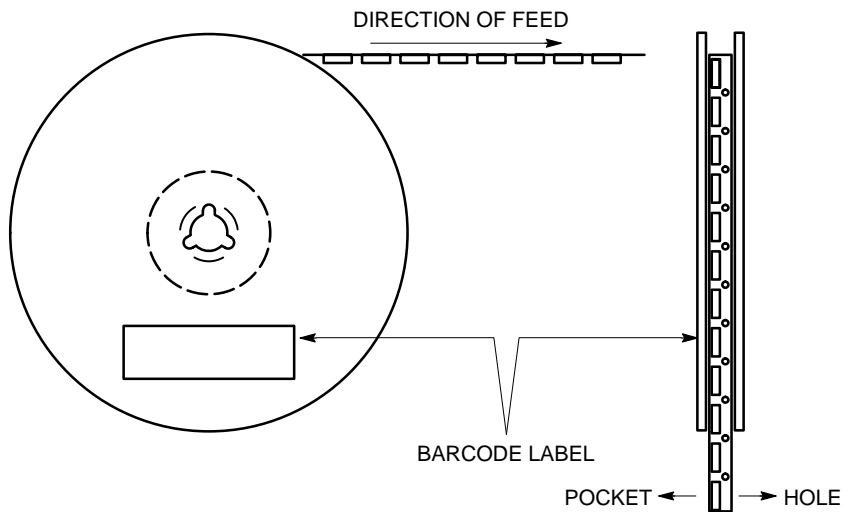

Figure 8. Reel Winding Direction

MC74LVX50

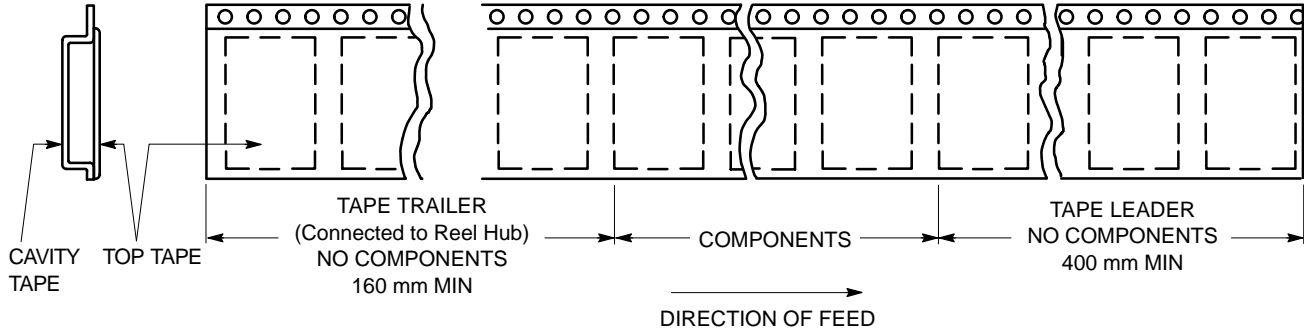

Figure 9. Tape Ends for Finished Goods

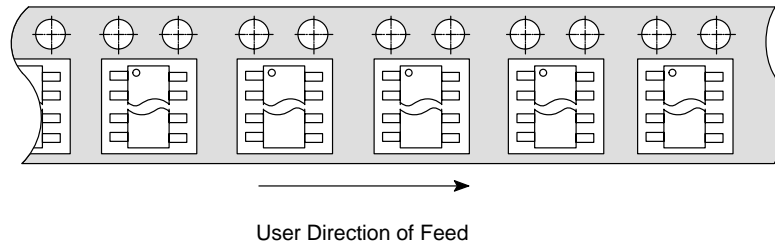

Figure 10. TSSOP and SOIC R2 Reel Configuration/Orientation

TAPE UTILIZATION BY PACKAGE

Tape Size	SOIC	TSSOP	QFN	SC88A / SOT-353 SC88/SOT-363
8 mm				5-, 6-Lead
12 mm	8-Lead	8-, 14-, 16-Lead	8-, 14-, 16-Lead	
16 mm	14-, 16-Lead	20-, 24-Lead	20-, 24-Lead	
24 mm	18-, 20-, 24-, 28-Lead	48-, 56-Lead	48-, 56-Lead	

MC74LVX50

PACKAGE DIMENSIONS

SOIC-14
D SUFFIX
CASE 751A-03
ISSUE G

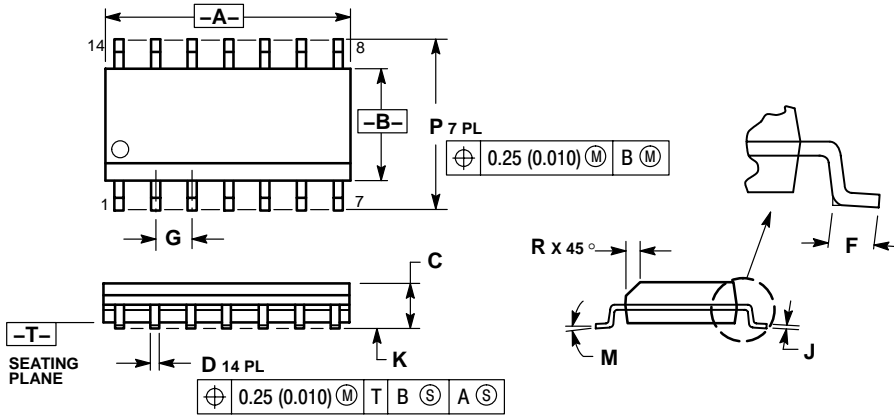

- NOTES:
1. DIMENSIONING AND TOLERANCING PER ANSI Y14.5M, 1982.
 2. CONTROLLING DIMENSION: MILLIMETER.
 3. DIMENSIONS A AND B DO NOT INCLUDE MOLD PROTRUSION.
 4. MAXIMUM MOLD PROTRUSION 0.15 (0.006) PER SIDE.
 5. DIMENSION D DOES NOT INCLUDE DAMBAR PROTRUSION. ALLOWABLE DAMBAR PROTRUSION SHALL BE 0.127 (0.005) TOTAL IN EXCESS OF THE D DIMENSION AT MAXIMUM MATERIAL CONDITION.

DIM	MILLIMETERS		INCHES	
	MIN	MAX	MIN	MAX
A	8.55	8.75	0.337	0.344
B	3.80	4.00	0.150	0.157
C	1.35	1.75	0.054	0.068
D	0.35	0.49	0.014	0.019
F	0.40	1.25	0.016	0.049
G	1.27 BSC		0.050 BSC	
J	0.19	0.25	0.008	0.009
K	0.10	0.25	0.004	0.009
M	0°	7°	0°	7°
P	5.80	6.20	0.228	0.244
R	0.25	0.50	0.010	0.019

TSSOP-14
DT SUFFIX
CASE 948G-01
ISSUE A

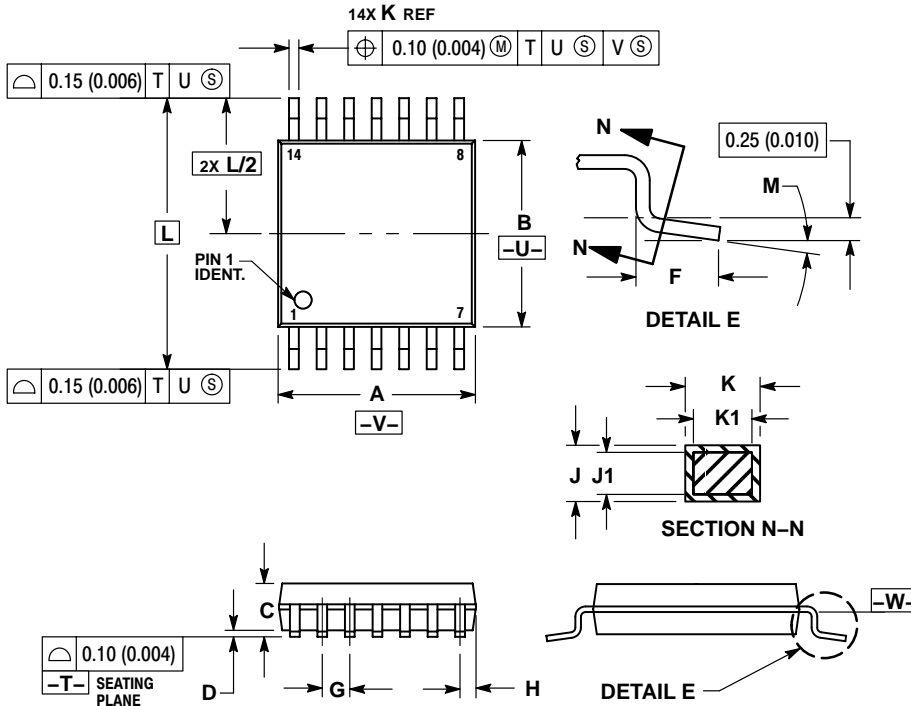

- NOTES:
1. DIMENSIONING AND TOLERANCING PER ANSI Y14.5M, 1982.
 2. CONTROLLING DIMENSION: MILLIMETER.
 3. DIMENSION A DOES NOT INCLUDE MOLD FLASH, PROTRUSIONS OR GATE BURRS. MOLD FLASH OR GATE BURRS SHALL NOT EXCEED 0.15 (0.006) PER SIDE.
 4. DIMENSION B DOES NOT INCLUDE INTERLEAD FLASH OR PROTRUSION. INTERLEAD FLASH OR PROTRUSION SHALL NOT EXCEED 0.25 (0.010) PER SIDE.
 5. DIMENSION K DOES NOT INCLUDE DAMBAR PROTRUSION. ALLOWABLE DAMBAR PROTRUSION SHALL BE 0.08 (0.003) TOTAL IN EXCESS OF THE K DIMENSION AT MAXIMUM MATERIAL CONDITION.
 6. TERMINAL NUMBERS ARE SHOWN FOR REFERENCE ONLY.
 7. DIMENSION A AND B ARE TO BE DETERMINED AT DATUM PLANE -W-.

DIM	MILLIMETERS		INCHES	
	MIN	MAX	MIN	MAX
A	4.90	5.10	0.193	0.200
B	4.30	4.50	0.169	0.177
C	---	1.20	---	0.047
D	0.05	0.15	0.002	0.006
F	0.50	0.75	0.020	0.030
G	0.65 BSC		0.026 BSC	
H	0.50	0.60	0.020	0.024
J	0.09	0.20	0.004	0.008
J1	0.09	0.16	0.004	0.006
K	0.19	0.30	0.007	0.012
K1	0.19	0.25	0.007	0.010
L	6.40 BSC		0.252 BSC	
M	0°	8°	0°	8°

MC74LVX50

PACKAGE DIMENSIONS

SOEIAJ-14
M SUFFIX
CASE 965-01
ISSUE O

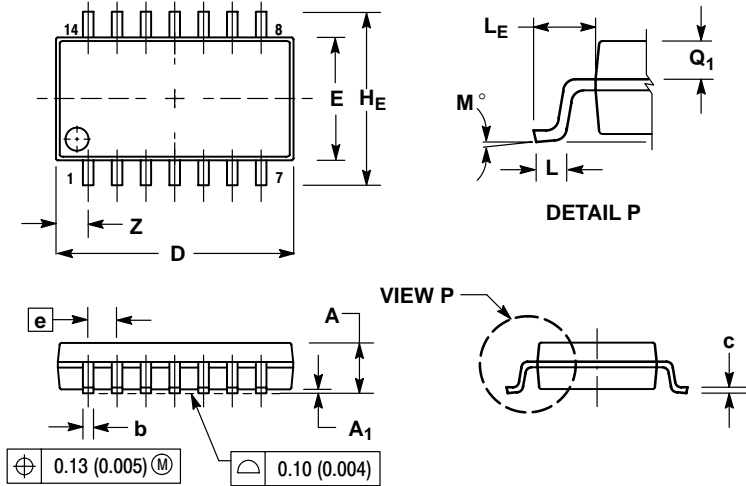

NOTES:

1. DIMENSIONING AND TOLERANCING PER ANSI Y14.5M, 1982.
2. CONTROLLING DIMENSION: MILLIMETER.
3. DIMENSIONS D AND E DO NOT INCLUDE MOLD FLASH OR PROTRUSIONS AND ARE MEASURED AT THE PARTING LINE. MOLD FLASH OR PROTRUSIONS SHALL NOT EXCEED 0.15 (0.006) PER SIDE.
4. TERMINAL NUMBERS ARE SHOWN FOR REFERENCE ONLY.
5. THE LEAD WIDTH DIMENSION (b) DOES NOT INCLUDE DAMBAR PROTRUSION. ALLOWABLE DAMBAR PROTRUSION SHALL BE 0.08 (0.003) TOTAL IN EXCESS OF THE LEAD WIDTH DIMENSION AT MAXIMUM MATERIAL CONDITION. DAMBAR CANNOT BE LOCATED ON THE LOWER RADIUS OR THE FOOT. MINIMUM SPACE BETWEEN PROTRUSIONS AND ADJACENT LEAD TO BE 0.46 (0.018).

DIM	MILLIMETERS		INCHES	
	MIN	MAX	MIN	MAX
A	---	2.05	---	0.081
A ₁	0.05	0.20	0.002	0.008
b	0.35	0.50	0.014	0.020
c	0.18	0.27	0.007	0.011
D	9.90	10.50	0.390	0.413
E	5.10	5.45	0.201	0.215
e	1.27 BSC		0.050 BSC	
H _E	7.40	8.20	0.291	0.323
L	0.50	0.85	0.020	0.033
L _E	1.10	1.50	0.043	0.059
M	0°	10°	0°	10°
Q ₁	0.70	0.90	0.028	0.035
Z	---	1.42	---	0.056

ON Semiconductor and  are registered trademarks of Semiconductor Components Industries, LLC (SCILLC). SCILLC reserves the right to make changes without further notice to any products herein. SCILLC makes no warranty, representation or guarantee regarding the suitability of its products for any particular purpose, nor does SCILLC assume any liability arising out of the application or use of any product or circuit, and specifically disclaims any and all liability, including without limitation special, consequential or incidental damages. "Typical" parameters which may be provided in SCILLC data sheets and/or specifications can and do vary in different applications and actual performance may vary over time. All operating parameters, including "Typicals" must be validated for each customer application by customer's technical experts. SCILLC does not convey any license under its patent rights nor the rights of others. SCILLC products are not designed, intended, or authorized for use as components in systems intended for surgical implant into the body, or other applications intended to support or sustain life, or for any other application in which the failure of the SCILLC product could create a situation where personal injury or death may occur. Should Buyer purchase or use SCILLC products for any such unintended or unauthorized application, Buyer shall indemnify and hold SCILLC and its officers, employees, subsidiaries, affiliates, and distributors harmless against all claims, costs, damages, and expenses, and reasonable attorney fees arising out of, directly or indirectly, any claim of personal injury or death associated with such unintended or unauthorized use, even if such claim alleges that SCILLC was negligent regarding the design or manufacture of the part. SCILLC is an Equal Opportunity/Affirmative Action Employer. This literature is subject to all applicable copyright laws and is not for resale in any manner.

PUBLICATION ORDERING INFORMATION

LITERATURE FULFILLMENT:

Literature Distribution Center for ON Semiconductor
P.O. Box 61312, Phoenix, Arizona 85082-1312 USA
Phone: 480-829-7710 or 800-344-3860 Toll Free USA/Canada
Fax: 480-829-7709 or 800-344-3867 Toll Free USA/Canada
Email: orderlit@onsemi.com

N. American Technical Support: 800-282-9855 Toll Free
USA/Canada

Japan: ON Semiconductor, Japan Customer Focus Center
2-9-1 Kamimeguro, Meguro-ku, Tokyo, Japan 153-0051
Phone: 81-3-5773-3850

ON Semiconductor Website: <http://onsemi.com>

Order Literature: <http://www.onsemi.com/litorder>

For additional information, please contact your
local Sales Representative.